

SUMMARY



Wires

Low	4
High	0
Coax	0
Triax	0
Quad	0
Fiber	0
Fluidic	0

Download

[Request a quote](#)

[Catalog](#)

Series	P
Termination type	Female solder
IP rating	50
Cable Ø	0.00 - 0.00 mm
Matching parts	PAG.M0.4GL.AC39A

TECHNICAL DETAILS

Mechanics

Shell Style/Model	PK*: Fixed receptacle with two nuts (back panel mounting)
Keying	1 key (alpha=0; Plug: male contact; Receptacle: female contact)
Housing Material	PSU (Polysulfone), gray
Cable Fixing	∅0 - 0 mm
Variant	A : Blue front nut

Performance

Configuration	1P.M04 : 4 Low Voltage
Insulator	
Rated Current	8 Amps

Specifications

Contact Type:	Solder
Max. Matings:	2000
Contact Dia.:	0.9 mm (0.0354in)
Bucket Dia.:	0.8 mm (0.031in)
Max. Solid Conductor:	0.34 mm ² (AWG 22)
Max. Stranded Conductor:	0.34 mm ² (AWG 22)
R (max):	4.5 mOhm
Test voltage (kV rms) Contact-contact:	1.2

Air clearance min. (mm) or Creepage distance min. (mm): 1.2

Others

F ret (min): 50 N
F ret (max): 150 N
IP Rating: 50

DRAWINGS

Draws

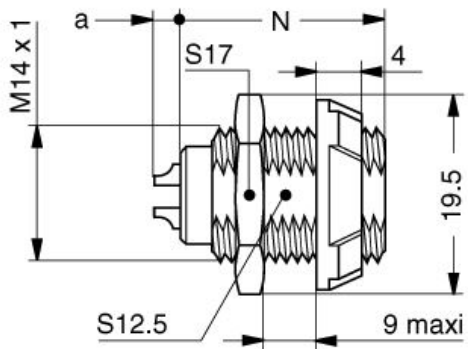

Dimensions

	A	Lmax	N
mm.	19.5	25	22.2
in.	0,77	0,98	0,87

RECOMMENDED BY LEMO

Tools

None

Cables